

Linear

LINI-R XL RGB Fixture Guide

KKDC

Indoor | Recessed | RGB output



Key applications

- ✓ Architectural detail
- ✓ Ceiling
- ✓ Direct lighting
- ✓ Downlighting
- ✓ Interior
- ✓ Special effect

Key features

- ✓ Custom lengths
- ✓ Constant Voltage (CV)
- ✓ Diffusion: homogenous
- ✓ Direct view
- ✓ Extensive CCT range
- ✓ IP40 dry area
- ✓ RGB

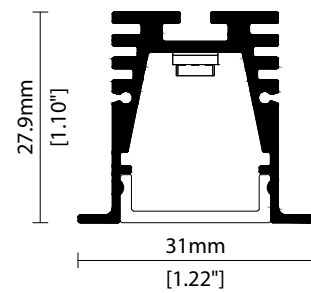

Linear

LINE-R XL RGB

Specification sheet

KKDC



Dimensions	H27.9/W31/L99-2016mm (H1.1/W1.22/L3.89-79.37in) (excluding spring clips)
PCB Cut-point	83.3mm increment/2000mm max (3.28in increment/78.74in max)
LED Pitch	13.9mm-72LED/m (0.55in - 22LED/ft)
Chip	RGB
Cover/Optics	Diffused (110°)
CCT	Red 620-625nm/Blue 455-460nm/Green 520-525nm
LED binning	5nm tolerance
CRI	N/A
Lifetime	50,000 hours @ 25°C (50,000 hours @ 77°F)
Operating temp	$T_a = -25$ to 55°C ($T_c \text{ max} = 66.5^\circ\text{C}$) $T_a = -13$ to 131°F ($T_c \text{ max} = 151.7^\circ\text{F}$)
IP Rating	IP40
Finish	Silver anodised
Mounting	Recessed mounting via spring clip
Power feed	Hardwire tails or male/female connectors
Control	DMX/DALI



Power consumption	Supply voltage	Supply current
15.6W/m (4.75W/ft)	24V DC	0.65A/m (0.20A/ft)

Diffused Cover

Red: 61lm/m (19lm/ft)
Green: 132lm/m (40lm/ft)
Blue: 22lm/m (7lm/ft)
RGB: 192lm/m (59lm/ft)

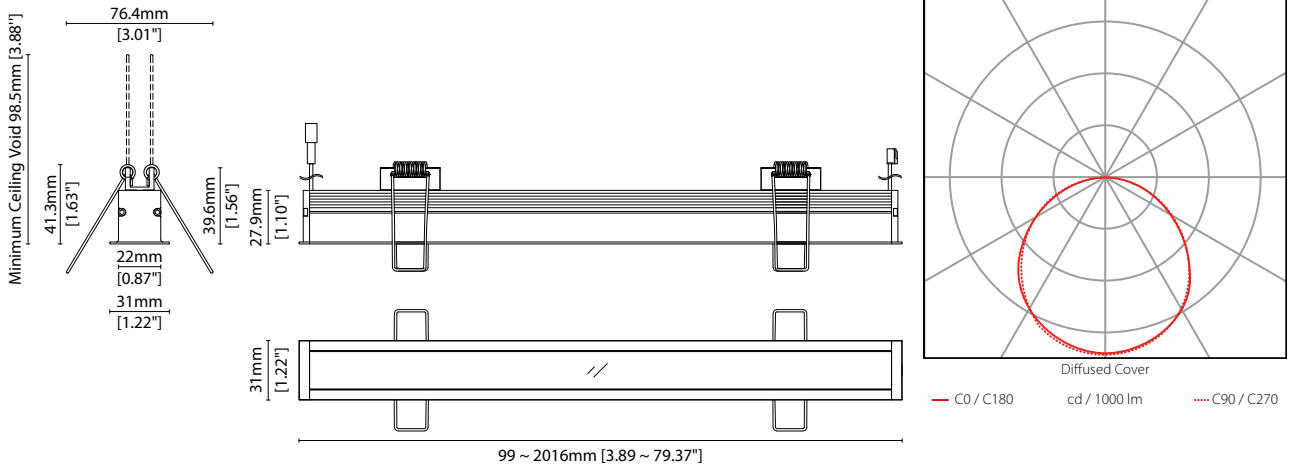

Data derived from IESNA LM-79-08 accredited testing of production samples.

See KKDC website for product document updates.

www.kkdc.lighting

LINIRXLRGBS-03.03EN-20241205

LINI-R XL RGB

Code Table



FIXTURE

Model	Finish	Cover	Grade	LED	Colour (CCT)	Length Availability ¹	IP	Cable Length	Power Feed ²	Input
LINI-R XL RX	Silver Anodised SA	Diffused C	s	501	RGB RGB	m 99.3-2016mm 83.3mm increments i 3.91-79.37in 3.28in increments (Specify length code OR total run length)	IP40 40	300mm/11.81" 0300 1000mm/39.37" 1000	Single no sheath tail S00X Double no sheath tail D00X Single no sheath IP20 connector S20X Double no sheath IP20 connector D20X	DC 24V g

¹ Refer to **Length Availability List** or enter total run length instead of length code

² Refer to **Power Feed Options** on **Options** pages

Code Example:

RX	-	SA	-	C	-	s	-	501	-	RGB	-	m	516	-	40	-	0300	-	D00X	-	g
LINI-R XL		Silver Anodised		Diffused				501		RGB		m	516mm		IP40		300mm/11.81"		Double no sheath tail		DC 24V

ACCESSORIES

Connection Accessories

KKCN-07	4 PIN RGB male & female 50mm/1.97" pair
KKCN-09	4 PIN RGB male & female 300mm/11.81" pair
KKCN-11	4 PIN RGB 300mm/11.81" extension lead

PSU/Driver

DALI/DMX

* Refer to **Driver/PSU Options** page for details or provide requirement and KKDC to offer the suitable option

* Refer to **Power feed** on **Accessories** pages

LED ENGINE VARIANTS (LED STRIP TYPE)

Colour	LED	Lumen/m	Lumen/ft	W/m	W/ft	Spec Doc	Length	Increment
Single CCT	R007	265	81	7	2.13	LINI-R XL R007	99-2016mm (3.89-79.37in)	41.7mm (3.28in)
	R014	534	163	14	4.27	LINI-R XL R014	99-2016mm (3.89-79.37in)	41.7mm (3.28in)
	R020	731	223	20	6.10	LINI-R XL A020	99-2016mm (3.89-79.37in)	41.7mm (3.28in)
	A040	2000	610	40	12.2	LINI-R XL A040	93-1516mm (3.66-59.68in)	38.46mm (1.51in)
Warm Dim/Dynamic White	R207	594	181	16	4.88	LINI-R XL R207	99-2016mm (3.89-79.37in)	83.3mm (3.28in)
RGB	501	Red 61 Green 132 Blue 22 RGB 192	Red 19 Green 40 Blue 7 RGB 59	15.6	4.75	LINI-R XL RGB	99-2016mm (3.89-79.37in)	83.3mm (3.28in)
RGBW	R201	441	134	20	6.10	LINI-R XL RGBW	141-2016mm (5.55-79.37in)	62.5 (2.46in)

* Performance data: diffused cover, RGB

LINI-R XL RGB

Length Availability List



Length Code		Fixture Length ¹		LED Strip ²		End Cap Dimension ³		Wattage (W)	Output (lm)			
Metric	Imperial(US)	Metric	Imperial(US)	Metric	Imperial(US)	Metric	Imperial(US)		R	G	B	W
m0099	i0004	99mm	3.91in	83mm	3.28in	11mm	0.43in	1.30	2	3	1	5
m0183	i0007	183mm	7.19in	167mm	6.56in	11mm	0.43in	2.60	3	7	1	10
m0266	i0010	266mm	10.47in	250mm	9.84in	11mm	0.43in	3.90	5	10	2	15
m0349	i0014	349mm	13.75in	333mm	13.12in	11mm	0.43in	5.20	6	13	2	20
m0433	i0017	433mm	17.04in	417mm	16.41in	11mm	0.43in	6.50	8	17	3	25
m0516	i0020	516mm	20.32in	500mm	19.69in	11mm	0.43in	7.80	10	20	4	30
m0599	i0024	599mm	23.60in	583mm	22.97in	11mm	0.43in	9.10	11	23	4	34
m0683	i0027	683mm	26.88in	667mm	26.25in	11mm	0.43in	10.40	13	27	5	39
m0766	i0030	766mm	30.16in	750mm	29.53in	11mm	0.43in	11.70	14	30	5	44
m0849	i0033	849mm	33.44in	833mm	32.81in	11mm	0.43in	13.00	16	33	6	49
m0933	i0037	933mm	36.72in	917mm	36.09in	11mm	0.43in	14.30	17	37	6	54
m1016	i0040	1016mm	40.00in	1000mm	39.37in	11mm	0.43in	15.60	19	40	7	59
m1099	i0043	1099mm	43.28in	1083mm	42.65in	11mm	0.43in	16.90	21	43	8	64
m1183	i0047	1183mm	46.57in	1167mm	45.94in	11mm	0.43in	18.20	22	47	8	69
m1266	i0050	1266mm	49.85in	1250mm	49.22in	11mm	0.43in	19.50	24	50	9	74
m1349	i0053	1349mm	53.13in	1333mm	52.50in	11mm	0.43in	20.80	25	53	9	79
m1433	i0056	1433mm	56.41in	1417mm	55.78in	11mm	0.43in	22.10	27	57	10	84
m1516	i0060	1516mm	59.69in	1500mm	59.06in	11mm	0.43in	23.40	29	60	11	89
m1599	i0063	1599mm	62.97in	1583mm	62.34in	11mm	0.43in	24.70	30	63	11	93
m1683	i0066	1683mm	66.25in	1667mm	65.62in	11mm	0.43in	26.00	32	67	12	98
m1766	i0070	1766mm	69.53in	1750mm	68.90in	11mm	0.43in	27.30	33	70	12	103
m1849	i0073	1849mm	72.81in	1833mm	72.18in	11mm	0.43in	28.60	35	73	13	108
m1933	i0076	1933mm	76.10in	1917mm	75.47in	11mm	0.43in	29.90	36	77	13	113
m2016	i0079	2016mm	79.38in	2000mm	78.75in	11mm	0.43in	31.20	38	80	14	118

¹ Actual total overall length of light fixture (LED strip + end caps + void/wire hole)

² Actual length of PCB strip

³ Actual length of 2x end caps

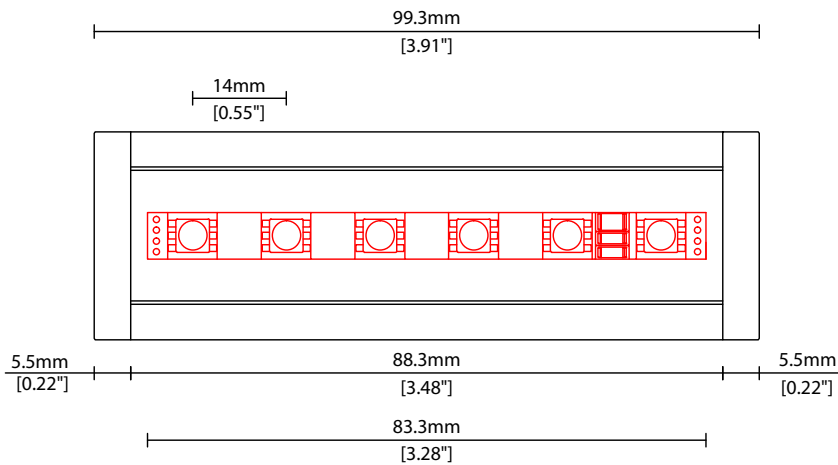



LINI-R XL RGB

Options



COVER/LENS OPTIONS

* Options are an integral part of the fixture ordering codes. Please refer to **Code Table** pages.

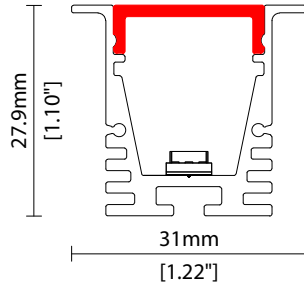

C Diffused cover
W31/H27.9mm (W1.22/H1.10")

POWER FEED OPTIONS

0300 S00X 300mm (11.81") Single no sheath tail

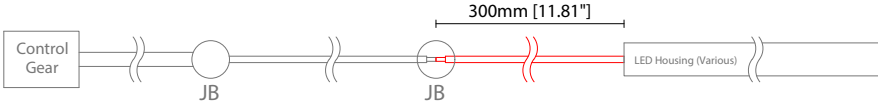

0300 D00X 300mm (11.81") Double no sheath tail

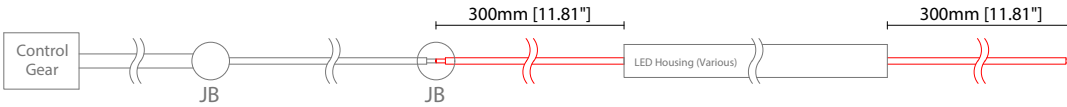

0300 S20X 300mm (11.81") Single no sheath IP20 connector

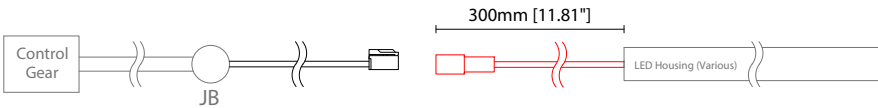

0300 D20X 300mm (11.81") Double no sheath IP20 connector

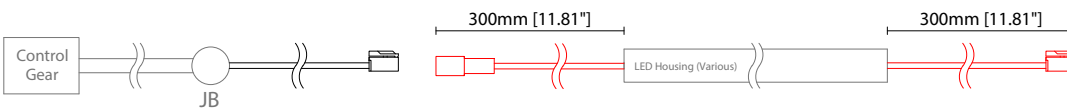

1000 S00X 1000mm (39.37") Single no sheath tail

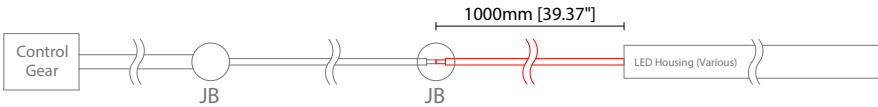

1000 D00X 1000mm (39.37") Double no sheath tail

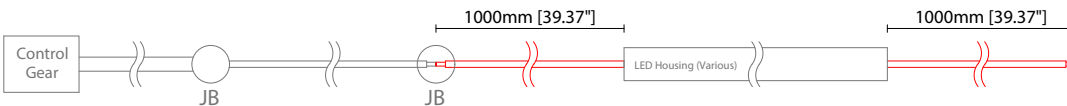

1000 S20X 1000mm (39.37") Single no sheath IP20 connector

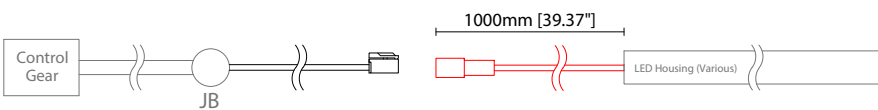

1000 D20X 1000mm (39.37") Double no sheath IP20 connector

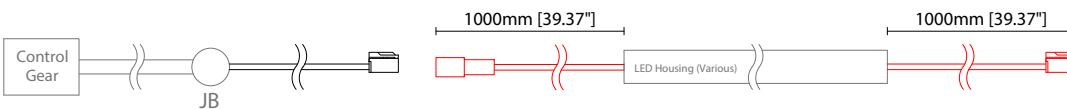

Key

- Control Gear Power supply, sub-controllers & control systems
- JB Junction box / cable connection

Linear

LINI-R XL RGB Options



POWER FEED OPTIONS (CONTINUED)

4 Pin RGB Female Connector

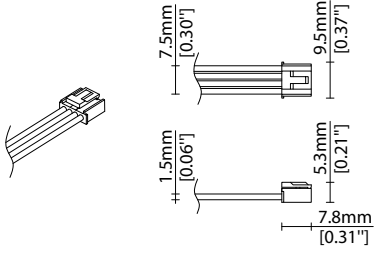

4 Pin RGB Male Connector

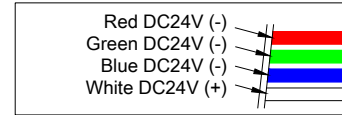
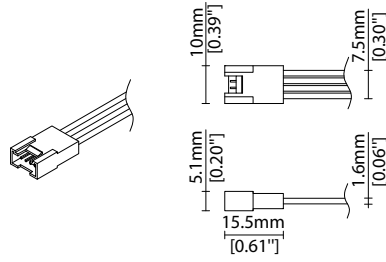

POWER FEED

Note: Accessories are to be ordered separately with corresponding code shown below.

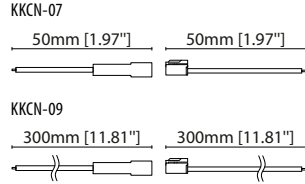

KKCN-07 50mm (1.97in) pair
KKCN-09 300mm (11.81in) pair
4 PIN RGB male + female
connector set

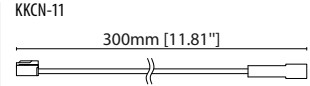

KKCN-11
4 PIN RGB 300mm (11.81in)
extension lead

KKDC CONTROL



IP20
Plastic housing
L170/W59/H29mm
(L6.69/W2.32/H1.14in)

KKDM-06 1-10V
visDIM dimmable sub-controller
(4 x 8A max @ 12-36V)



IP20
Plastic housing
L170/W53.4/H28mm
(L6.69/W2.10/H1.10in)

KKSC-05 DMX
visDIM dimmable sub-controller
(4 x 5A max @ 12-36V)



IP20
Plastic housing
L170/W59/H29mm
(L6.69/W2.32/H1.14in)

KKDL-02 DALI
visDIM dimmable sub-controller
(4 x 8A max @ 12-36V)



IP20
Plastic housing
L166/W53.4/H23mm
(L6.54/W2.10/H0.91in)

KKDL-03 DALI
visDIM dimmable sub-controller
(4 x 5A max @ 12-36V)

AVAILABLE PSU OPTIONS

Control Mode	PSU (Order Code)	Input Voltage AC	Output Voltage DC	Rated Output Current	Rated Power	Dim %	IP Rating
Switched	CEN-60-24	90-295V	24V	2.5A	60W	-	IP67
	HLG-60H-24	90-305V	24V	2.5A	60W	-	IP67
	HLG-100H-24	90-305V	24V	4.0A	100W	-	IP67
	HLG-150H-24	90-305V	24V	6.3A	150W	-	IP67
	HLG-240H-24	90-305V	24V	10A	240W	-	IP67
0-10V (1-10V)	PWM-40-24	90-305V	24V	1.67A	40W	100-0.15 (100-10)	IP67
	PWM-60-24	90-305V	24V	2.5A	60W	100-0.15 (100-10)	IP67
	PWM-90-24	90-305V	24V	3.67A	90W	100-0.15 (100-10)	IP67
	PWM-120-24	90-305V	24V	5.0A	120W	100-0.15 (100-10)	IP67
DALI	LIN100A1	120-277V	24V	1A per channel	100W	100-0.1	IP66/IP40
DMX RGB	LIN100A1	120-277V	24V	1.33A per channel	100W	100-0.1	IP66/IP40
DMX RGBW	LIN100A1	120-277A	24V	1A per channel	100W	100-0.1	IP66/IP40

Flicker Free Options - Combination of PSU+ sub-controller

Control Mode	PSU (Order Code)	Sub-controller (Order Code)	Input Voltage AC	Output Voltage DC	Rated Output Current	Rated Power	Dim %	IP Rating PSU/ Sub-controller
0-10V or 1-10V	CEN-60-24	KKDM-06	90-295V	24V	2.5A	60W	100-0.9	IP67/IP20
	HLG-60H-24	KKDM-06	90-295V	24V	2.5A	60W	100-0.9	IP67/IP20
	HLG-100H-24	KKDM-06	90-295V	24V	4.0A	100W	100-0.9	IP67/IP20
	HLG-150H-24	KKDM-06	90-295V	24V	6.3A	150W	100-0.9	IP67/IP20
	HLG-240H-24	KKDM-06	90-295V	24V	10.0A	240W	100-0.9	IP67/IP20
DALI	CEN-60-24	KKDL-02/03	90-295V	24V	2.5A	60W	100-0.1	IP67/IP20
	HLG-60H-24	KKDL-02/03	90-305V	24V	2.5A	60W	100-0.1	IP67/IP20
	HLG-100H-24	KKDL-02/03	90-305V	24V	4.0A	100W	100-0.1	IP67/IP20
	HLG-150H-24	KKDL-02/03	90-305V	24V	6.3A	150W	100-0.1	IP67/IP20
	HLG-240H-24	KKDL-02/03	90-305V	24V	10.0A	240W	100-0.1	IP67/IP20
DMX RGB	CEN-60-24	KKSC-05	90-295V	24V	2.5A	60W	100-0.9	IP67/IP20
	HLG-60H-24	KKSC-05	90-305V	24V	2.5A	60W	100-0.9	IP67/IP20
	HLG-100H-24	KKSC-05	90-305V	24V	4A	100W	100-0.9	IP67/IP20
	HLG-150H-24	KKSC-05	90-305V	24V	6.3A	150W	100-0.9	IP67/IP20
	HLG-240H-24	KKSC-05	90-305V	24V	10.0A	240W	100-0.9	IP67/IP20

¹ The items shown above cover the most frequently used specification but does not exhaust the possible options

² PSU and/or driver can be chosen from the table, or KKDC may recommend the best option upon receipt of the controls requirement and installation environment

³ Electrical shop drawing will include detailed information of PSU and relevant control drivers

⁴ Cut sheets are available on the controls section of www.kkdc.lighting or upon request